



Dentsply® Sirona Cavitron® Steri-Mate® Ultrasonic Handpiece on A-dec 532/533/541 Delivery Systems INSTALLATION GUIDE

Contents

Before You Begin	1
532B/533B: Install the Handpiece Tubing and Control Module	2
541B: Install the Handpiece Tubing and Control Module ..	18
Test the Installation	29
Reinstall the Covers	31
Regulatory Information and Warranty	36



Product Models and Versions Covered in This Document

Models	Versions	Description
532/533/541	B	Delivery System

Before You Begin



CAUTION When removing or replacing covers, take care not to damage any wiring or tubing. Verify that the covers are secure after replacing them.



ATTENTION Circuit boards are sensitive to static electricity. Electrostatic Discharge (ESD) precautions are required when touching a circuit board or making connections to or from the circuit board. Circuit boards should be installed only by an electrician or qualified service person.

Required Tools

- Anti-static wrist strap
- Pliers
- Sleeve pusher
- Diagonal cutters
- Standard and Phillips head screwdriver
- Wire strippers

532B/533B: Install the Handpiece Tubing and Control Module

Prepare the Chair and Delivery System	2
Install the Handpiece Tubing	2
Mount the Control Module on the Module Shelf	9
Connect the Control Module Electrical Wiring	11
Connect the Handpiece Tubing to the Control Block	14

Prepare the Chair and Delivery System

- 1 Turn on the power to the system.
- 2 Fully raise the chair base and back.



WARNING Failure to turn off or disconnect the power before you begin this procedure can lead to product damage and result in serious injury or death.

- 3 Turn off the power to the system.

Install the Handpiece Tubing

532B: Install the Handpiece Tubing	3
533B: Install the Handpiece Tubing	7

532B: Install the Handpiece Tubing

1 Swivel the touchpad to the side.



2 Push up on the cover release at the back of the control head and lift the top cover off the control head.

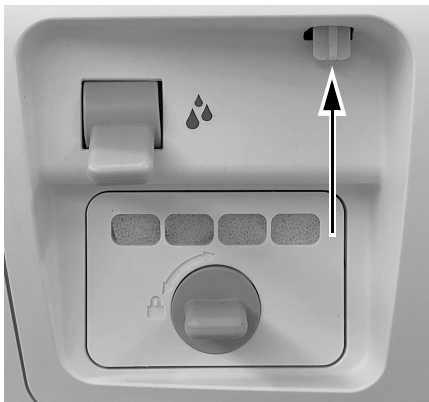

3 Pull the front cover off the control head.

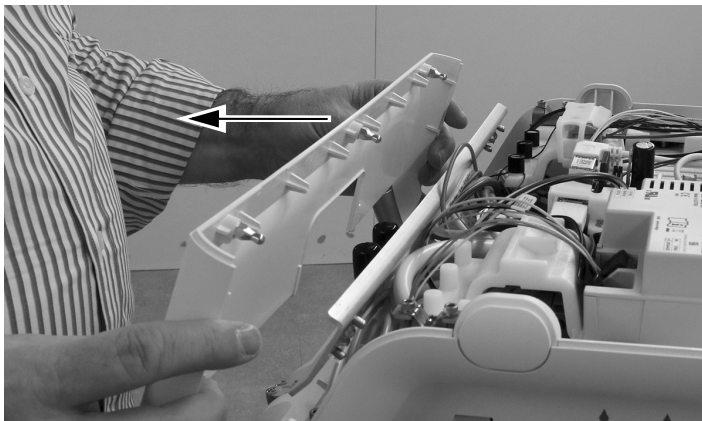

- 4** Locate the ultrasonic handpiece tubing above the opening in the control head behind the holder position where you want to install the ultrasonic handpiece.

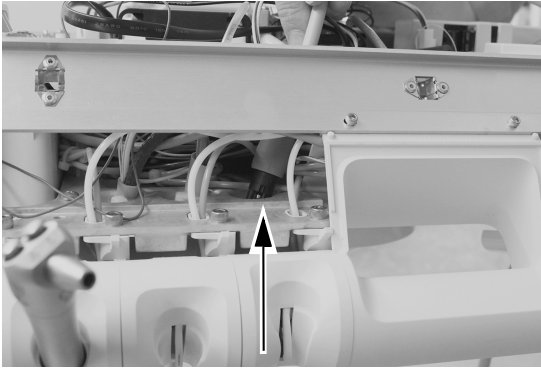

CAUTION Do not remove the aluminum panel on the front of the delivery system. The screws that secure the plate screw into plastic, not metal. Repeated removal of the screws over time will deform the plastic and loosen the front cover of the delivery system.

- 5** Drop the ultrasonic handpiece tubing down through the opening in the control head behind the holder position where you want to install the ultrasonic handpiece.

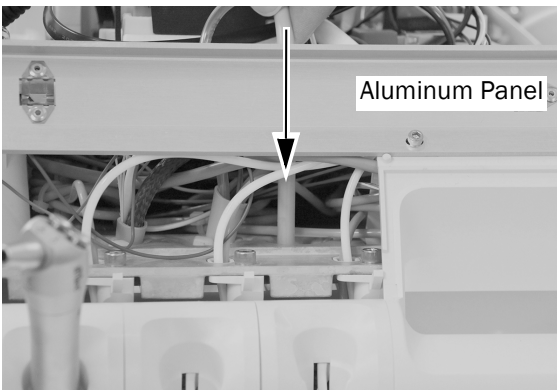

- 6** Set the ultrasonic handpiece tubing nut into the desired holder position.

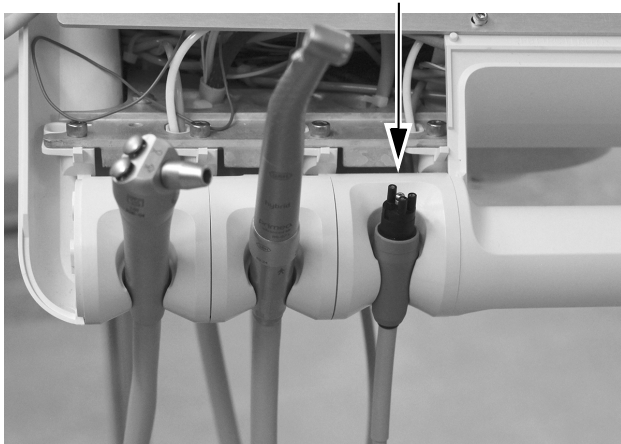

- 7 Adjust the drape of the tubing to match the drape of the other tubing on the control head and mark the tubing sheath about 1/2" (12 mm) above the chassis.



- 8 Cut the tubing sheath back to the mark and cut off the sheath.



- 9 Insert the tubing up through the chassis. Place a cable tie around the tubing about 1/2" (12 mm) below the mark on the tubing. Create a large loop with the cable tie and do not tighten it.

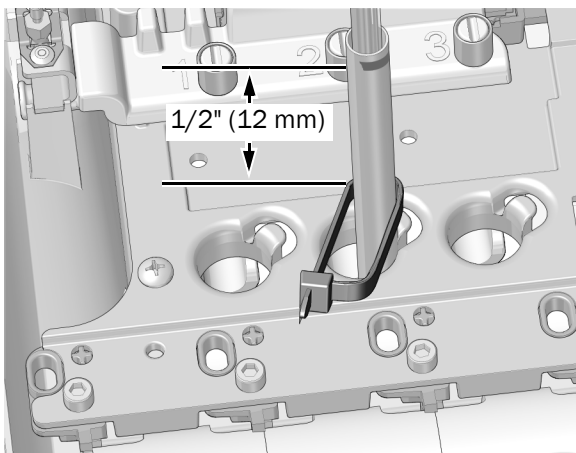

NOTE The aluminum panel is not shown to enhance visibility.

- 10** Position the cable tie loop around the post at the edge of the tubing hole in the chassis. Be sure the loop in the cable tie is behind the post.

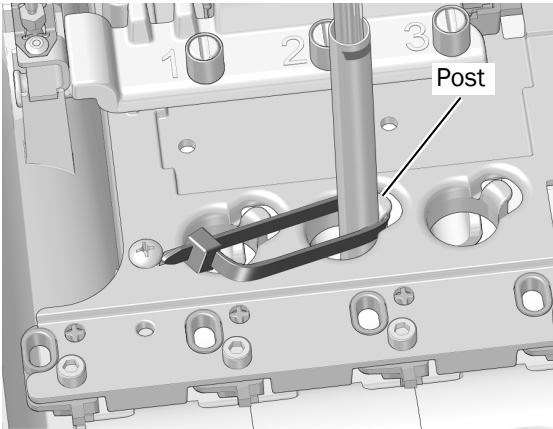

- 11** Push the cable tie down so it is below the top of the post. Tighten the cable tie, ensuring the cable tie remains around the post. Cut off the excess cable tie.

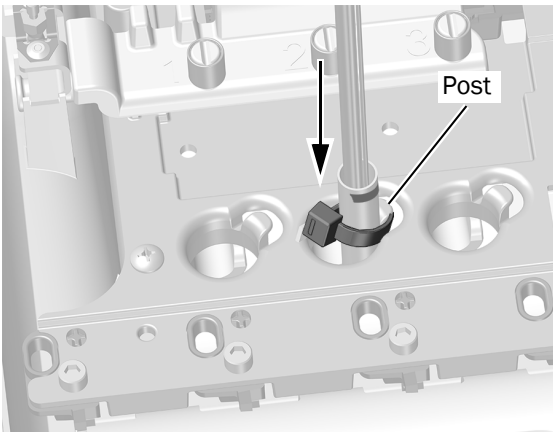

- 12** Place the strain relief cord across the top of the post on the support bracket, which corresponds to the position you placed the tubing into, and cover the post with the black shield. Cut off the excess strain relief cord.

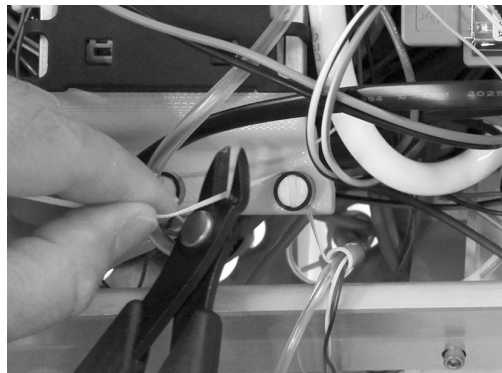
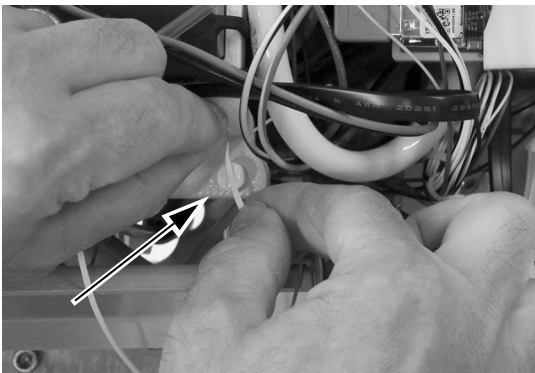

Next Step Continue with "Mount the Control Module on the Module Shelf" on page 9.

533B: Install the Handpiece Tubing

- 1 Lift the corner of the instrument pad on the side of the delivery system on which you are going to install the ultrasonic handpiece.

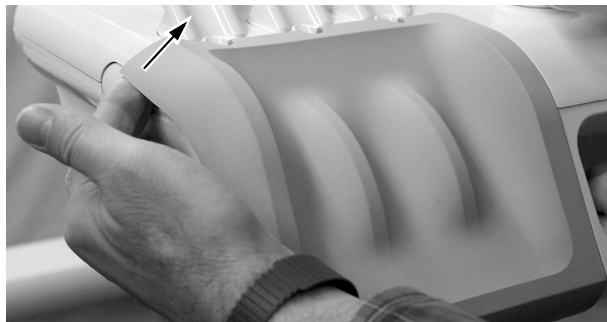

- 2 Carefully pull the instrument pad away from the control head.

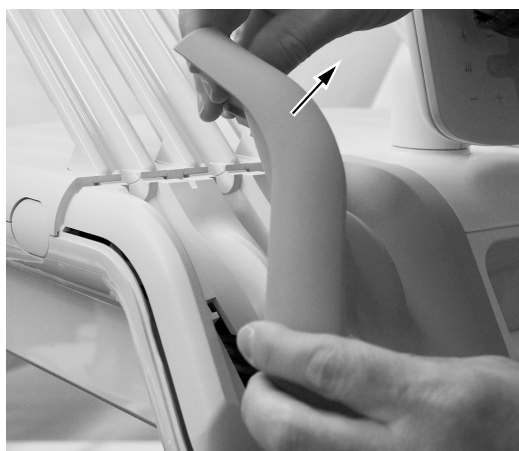

- 3 Rotate the side of the tubing guide forward.

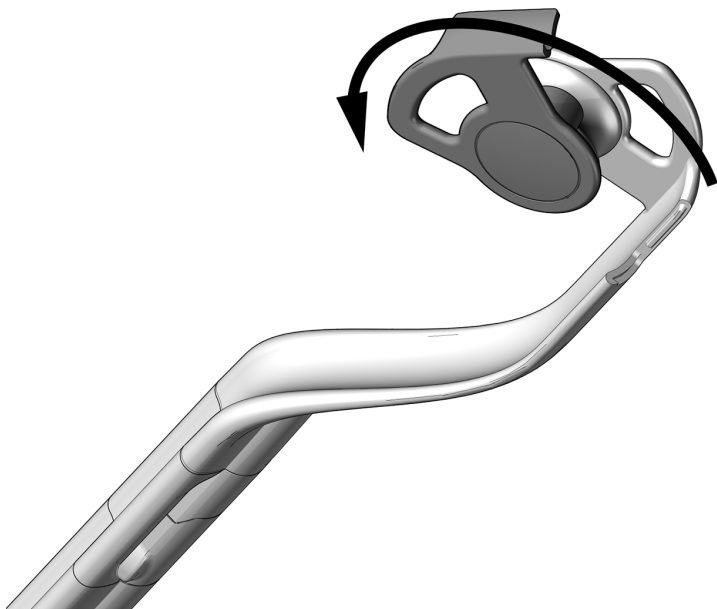

- 4** Route the tubing through the whip assemblies.
- 5** Close the tubing guide and make sure it snaps shut.

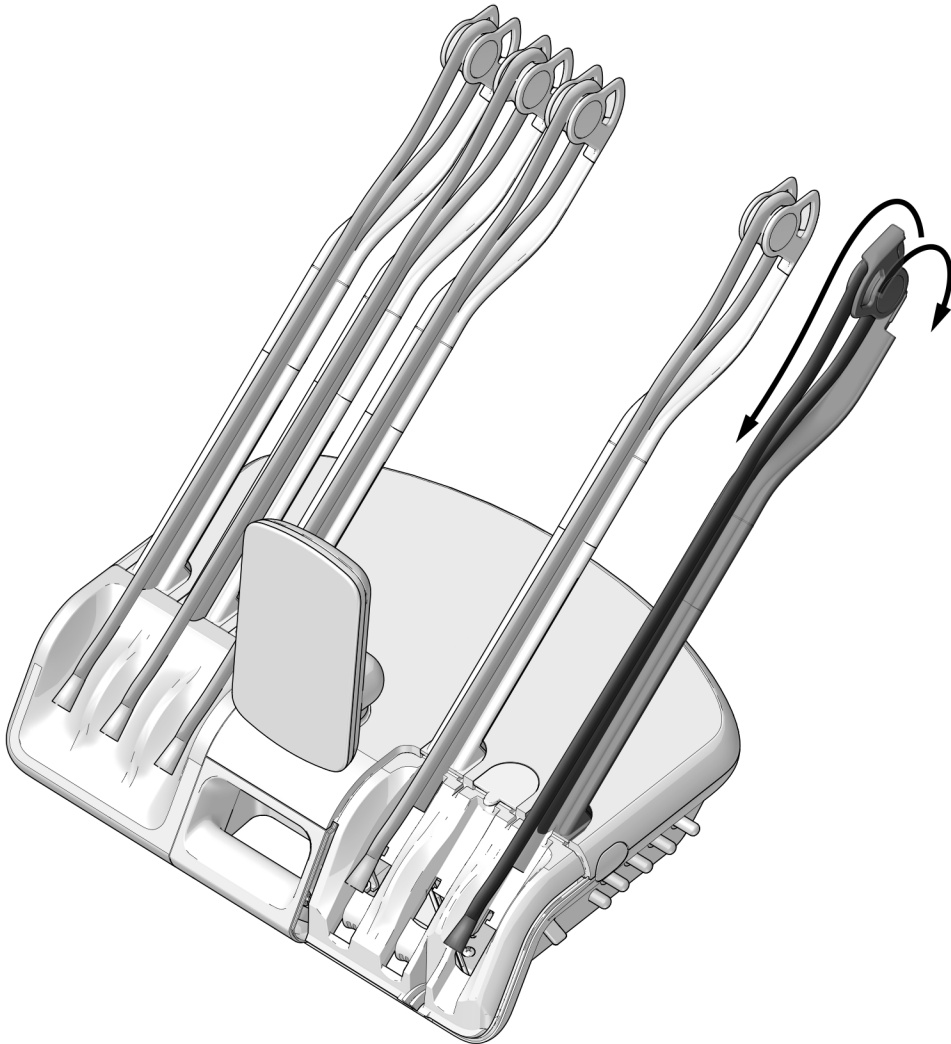

Mount the Control Module on the Module Shelf

- 1 To ensure maximum flexibility for future installations, note the recommended placement of the control module as shown below.

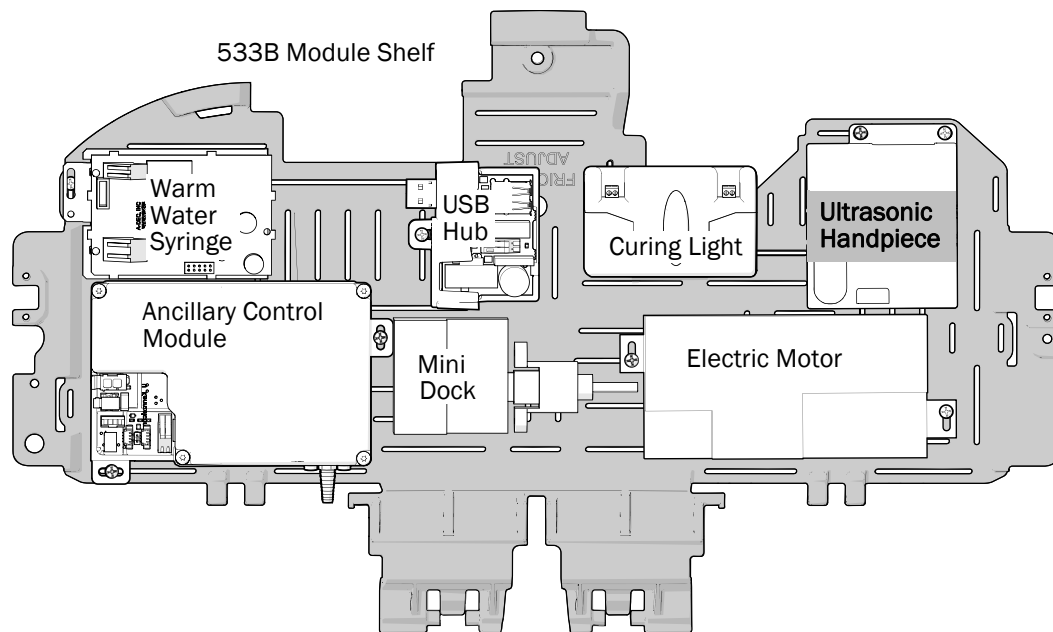
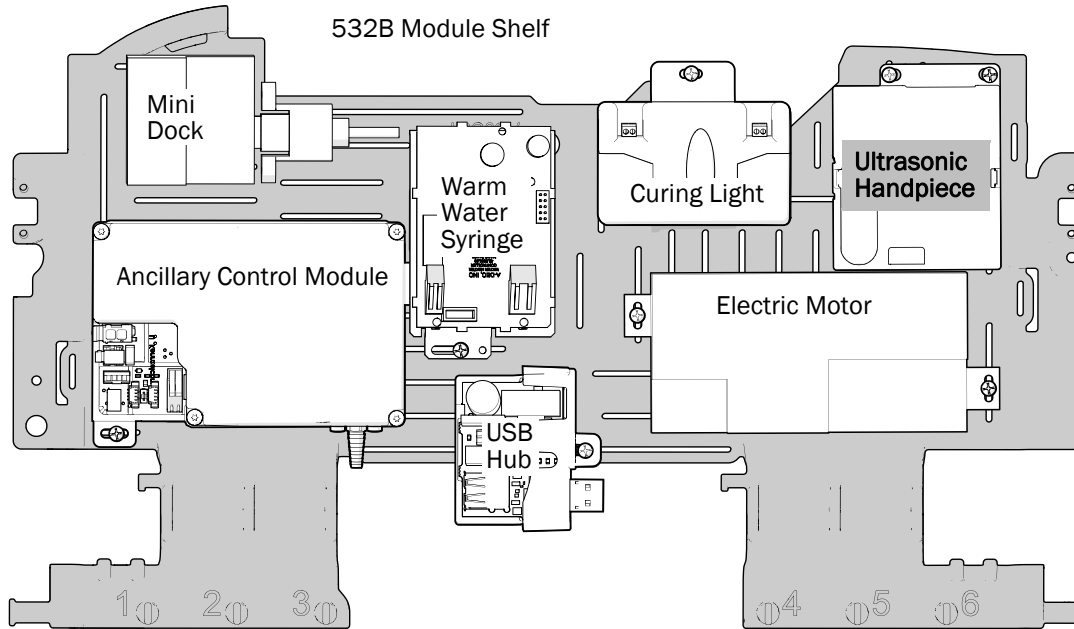



ATTENTION Circuit boards are sensitive to static electricity. Electrostatic Discharge (ESD) precautions are required when touching a circuit board or making connections to or from the circuit board. Circuit boards should be installed only by an electrician or qualified service person.

- 2 Place a grounding strap on one wrist and connect the other end of the grounding strap to the grounding lug mounted on the flush toggle at the back of the control head.



- 3 Place the control module on the module shelf. Orient the control module as shown below. Secure the module to the module shelf with two screws.



NOTE You may need to move other modules to properly secure the control module to the module shelf.

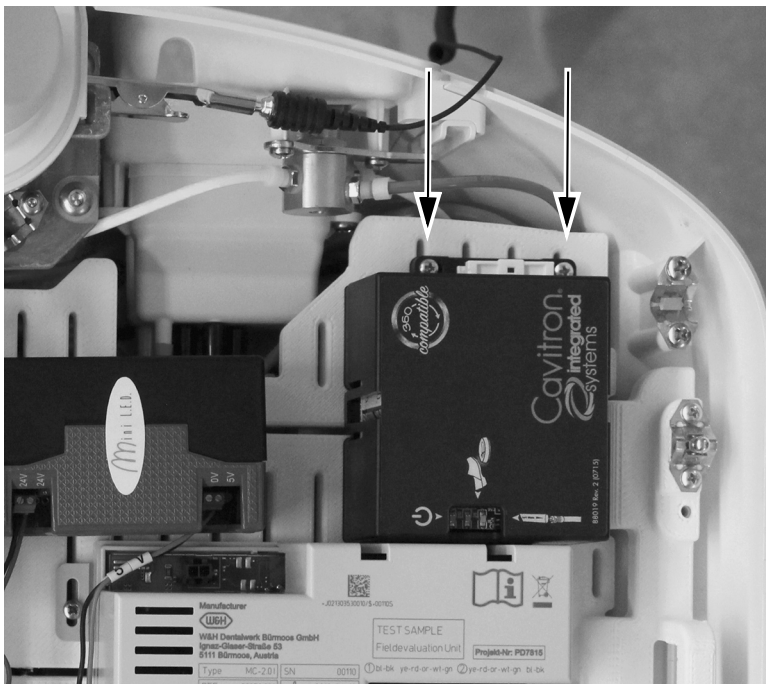

Connect the Control Module Electrical Wiring

- 1 Connect the adaptor harness to the ultrasonic handpiece control module.

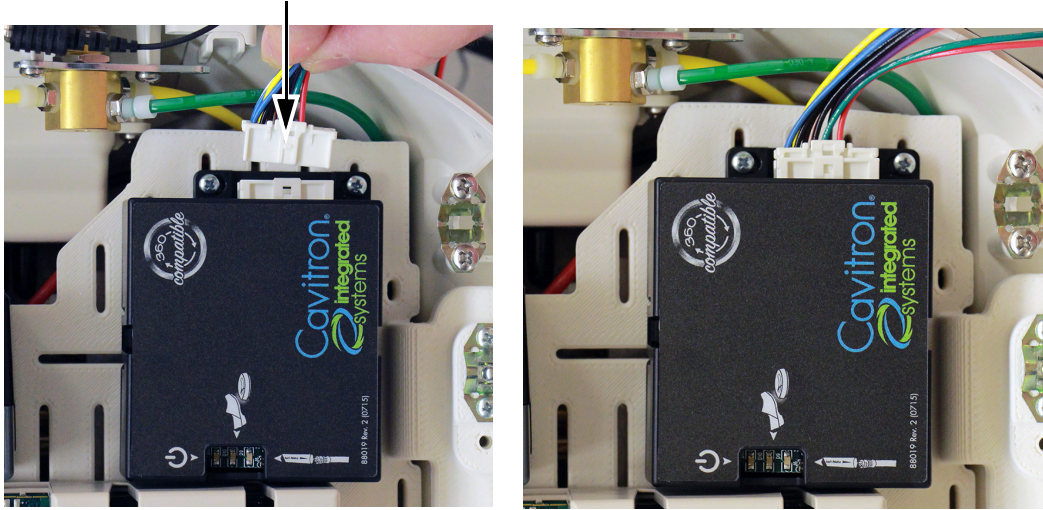

- 2 Connect the 4-pin socket from the ultrasonic handpiece tubing to the 4-pin plug from the adaptor harness.

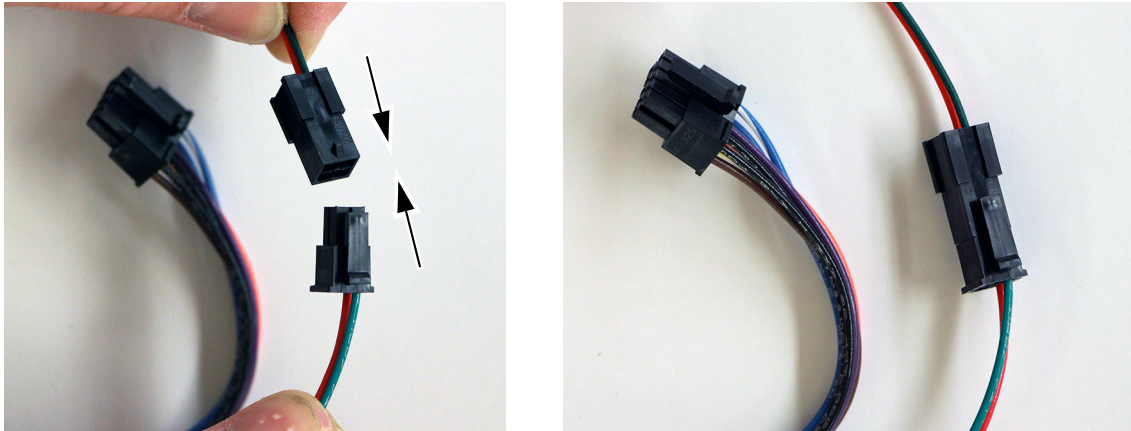

- 3 Connect the 10-pin socket from the control harness to the 10-pin plug from the adaptor harness.

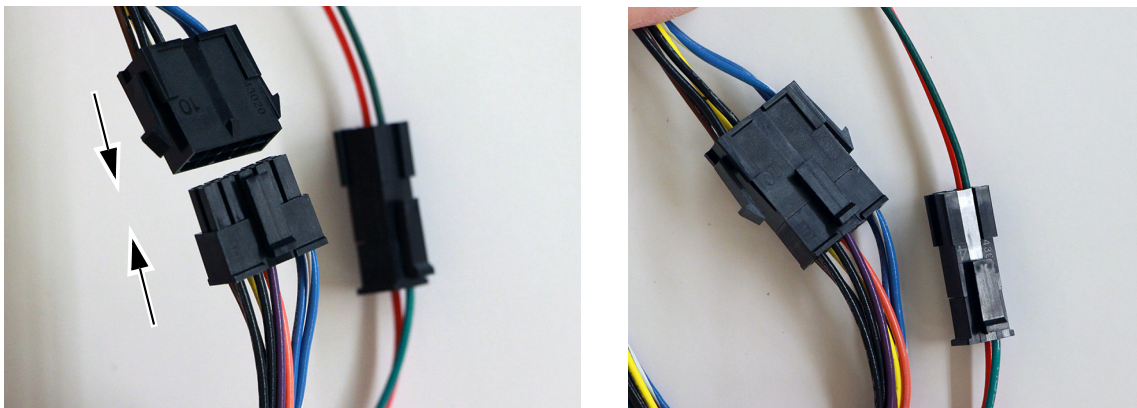

- 4** Route the wiring from the 10-pin connector toward the front of the control head and then down under the module shelf.

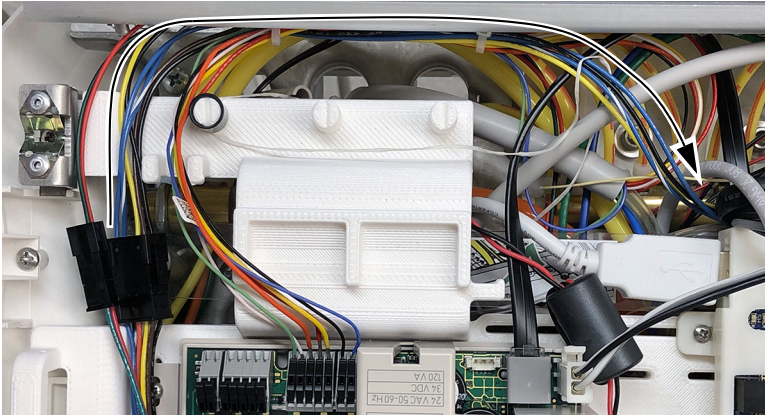

- 5** Lift the module shelf up and route the blue, blue with white stripes, black, and yellow wires from the 10-pin connector toward the delivery system circuit board.

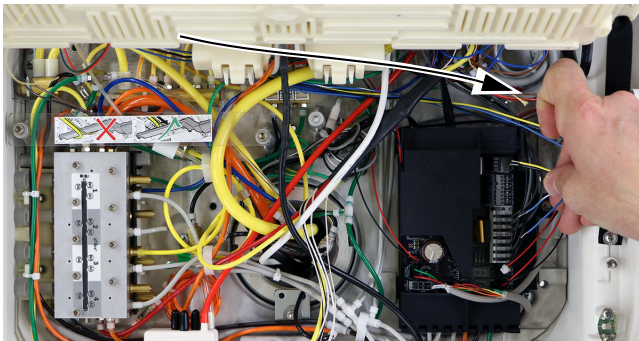

CAUTION Do not connect the black and yellow wires to the 0 VAC or 24 VAC SCALER terminals.

- 6** Connect the blue, blue with white stripe, black, and yellow wires to the delivery system circuit board.

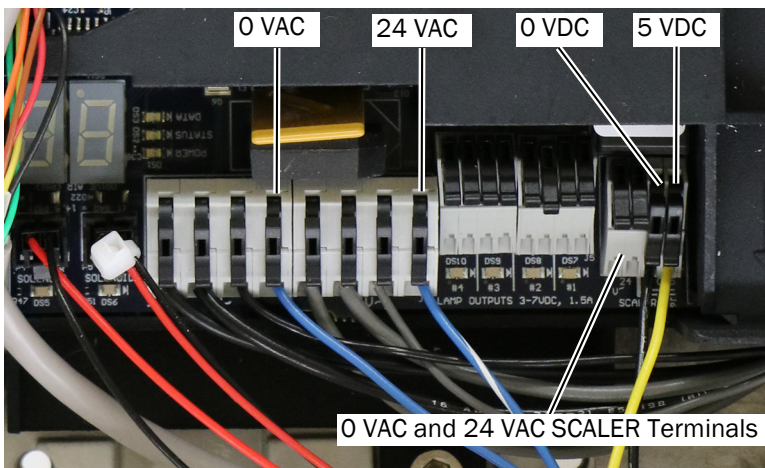

Connect the wires as follows:

- Blue to 0 VAC
- Blue with White Stripe to 24 VAC
- Black to 0 VDC
- Yellow to 5 VDC



NOTE Ensure that the circuit board contacts do not close on the insulation of the wire.

- 7 Route the brown and black wires attached to the air-electric switch into the center of the lower deck.

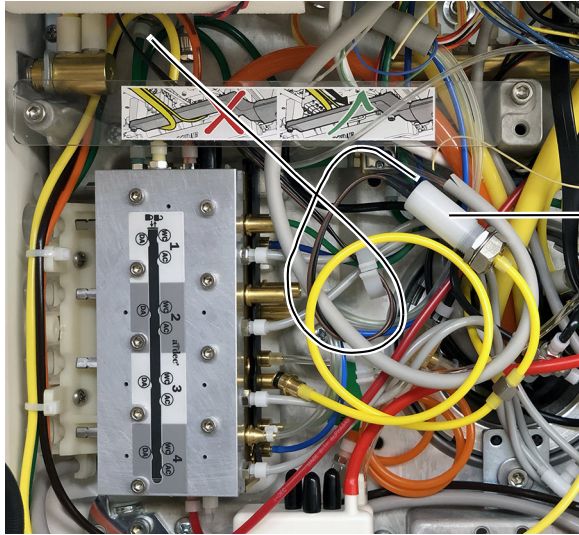

Air-Electric Switch

Connect the Handpiece Tubing to the Control Block

- 1 Connect the clear water tube from the handpiece tubing to the OUT barb on the water regulator.

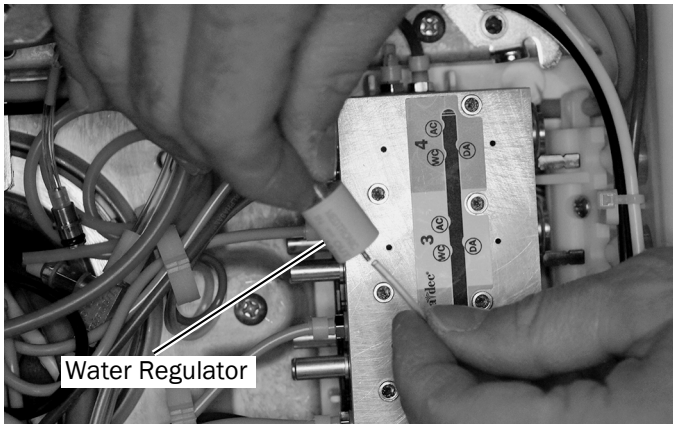

- 2 Use a 5/32" hex key to loosen the screw securing the control block lock. Turn the control block lock to the unlocked position.
- 3 Lift the control block to gain better access.
- 4 Move the slide lock to the open position.

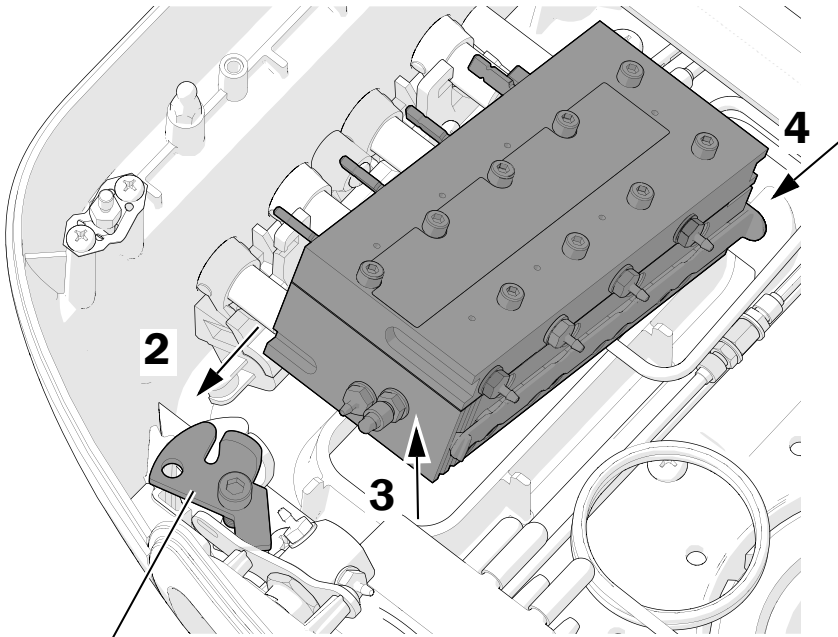

Control Block Lock in Unlocked Position

- 5 Attach the clear water line tubing from the IN barb on the water regulator to the appropriate WC water coolant port on the control block.

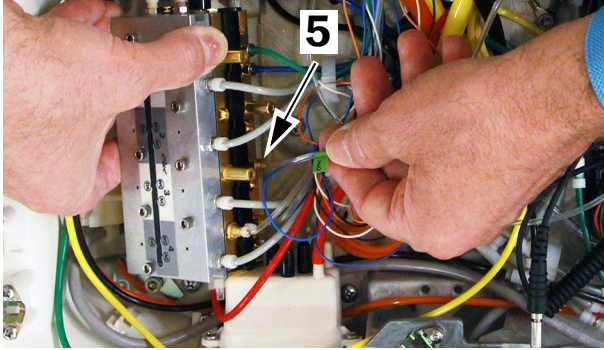

- 6 Connect the air-electric switch drive air quick-disconnect adaptor to the DA port for the desired handpiece position on the control block.

- 7 Insert a quick-disconnect plug into the AC drive air port on the control block.

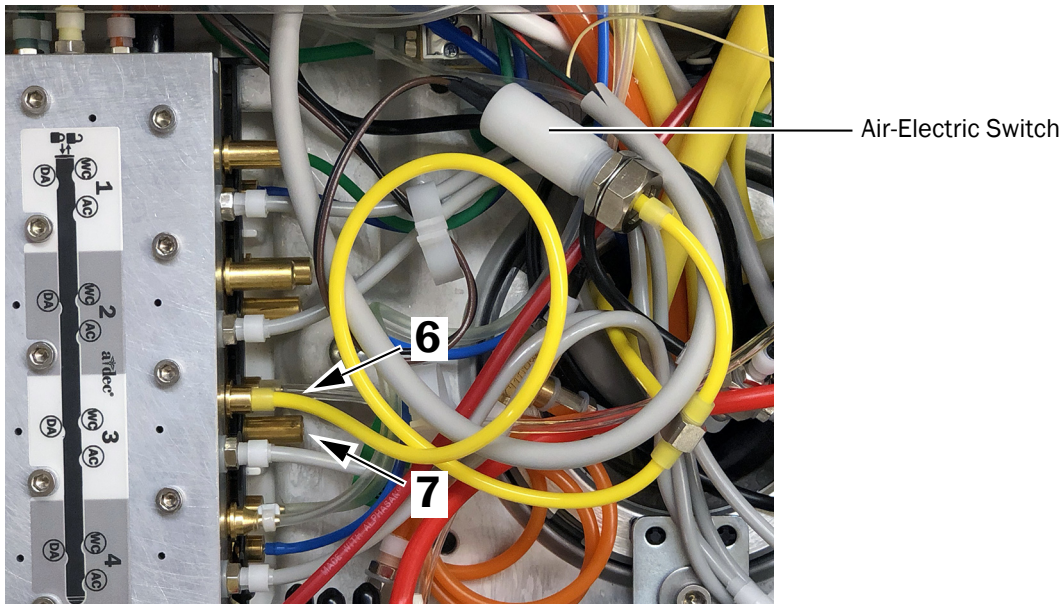

8 Close the slide lock that secures the quick disconnect plugs.

9 Move the control block lock to the locked position and tighten the hex-head screw to secure the lock.

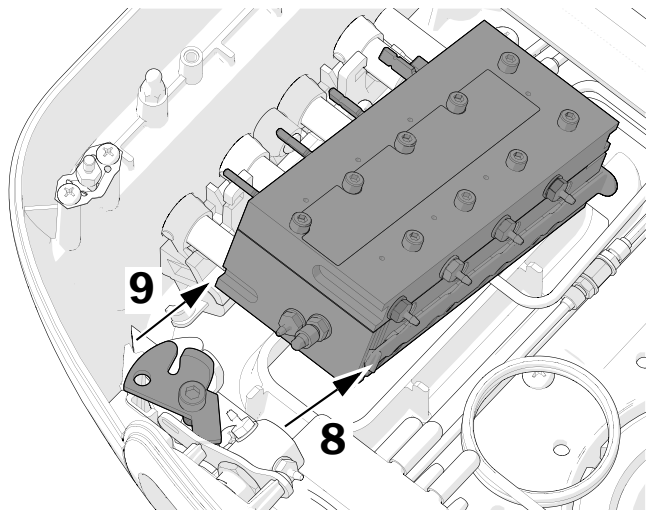

Next Step **532B Only:** Continue with “Configure the Handpiece Settings” on page 28.

533B Only: Continue with “533B: Close the Cover” on page 17.

533B: Close the Cover



CAUTION When removing or replacing covers, take care not to damage any wiring or tubing. Verify that the covers are secure after replacing them.

- 1** Lower the top cover. Be careful not to kink or pinch any tubing. Squeeze the back of the cover and the control head together to ensure the cover is fully seated on the control head.

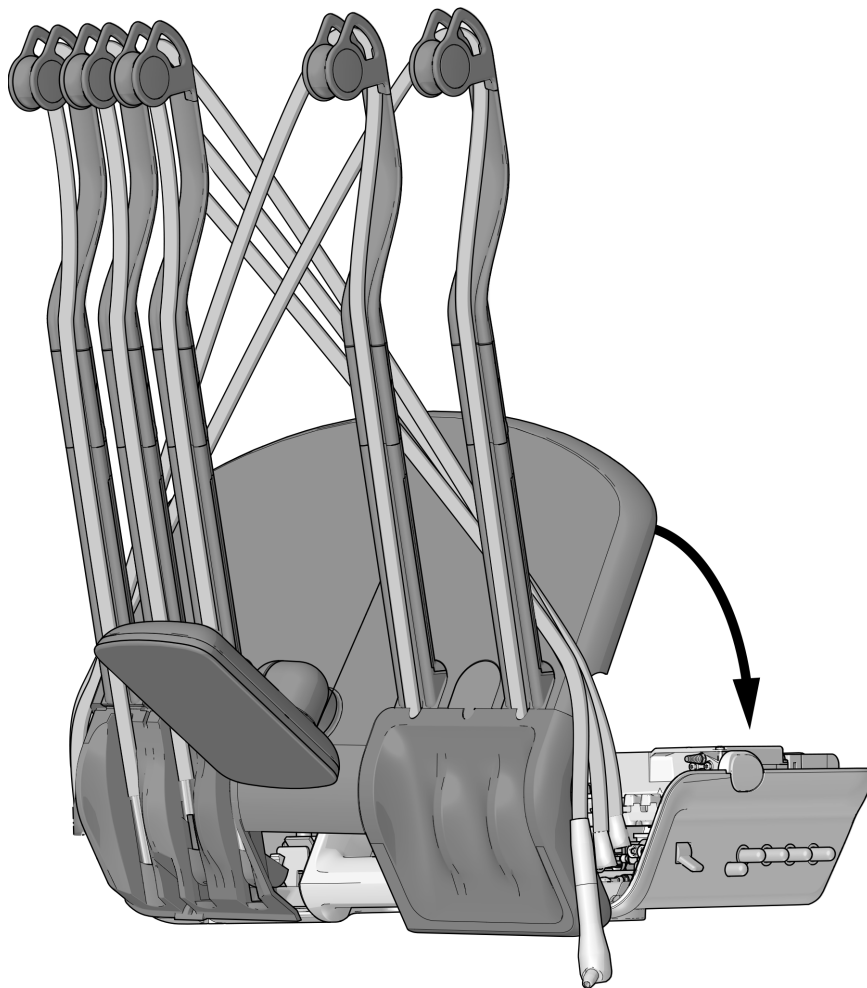

- 2** Replace the handpiece tubing in their normal position on the whips.

Next Step Continue with “Configure the Handpiece Settings” on page 28.

541B: Install the Handpiece Tubing and Control Module

Prepare the Delivery System	18
Remove the Delivery System Covers	18
Install the Handpiece Tubing	19
Mount the Control Module on the 12 O'Clock Frame Unit	21
Connect the Handpiece Tubing to the Control Block	25

Prepare the Delivery System



WARNING Failure to turn off or disconnect the power before you begin this procedure can lead to product damage and result in serious injury or death.

- 1 Turn off the power to the system using the master toggle.

Remove the Delivery System Covers

- 1 Pull the side covers out at the bottom and pull them away from the delivery system.



Install the Handpiece Tubing

- 1 Set the tubing nut into the desired holder position.

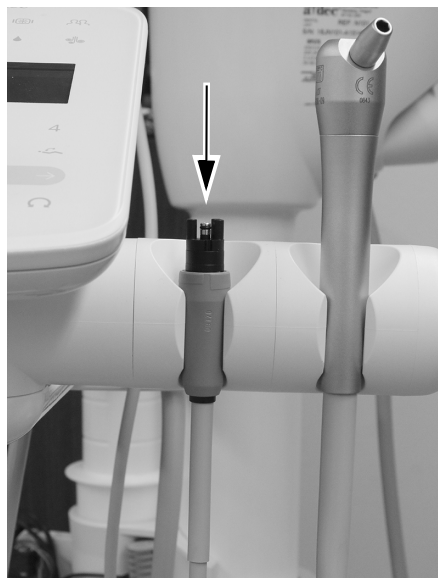

- 2 On the underside of the instrumentation arm, use a 5/32" hex key to remove the screw that secures the top cover on the instrumentation arm.

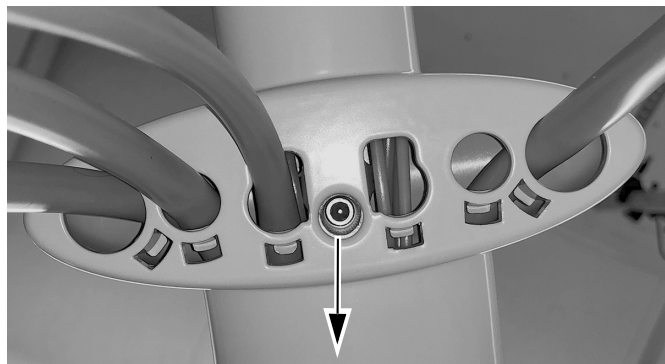

- 3 Slide the top cover away from the touchpad and remove the top cover.

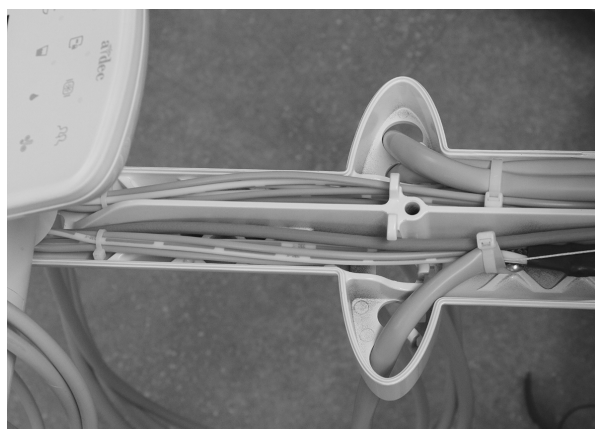
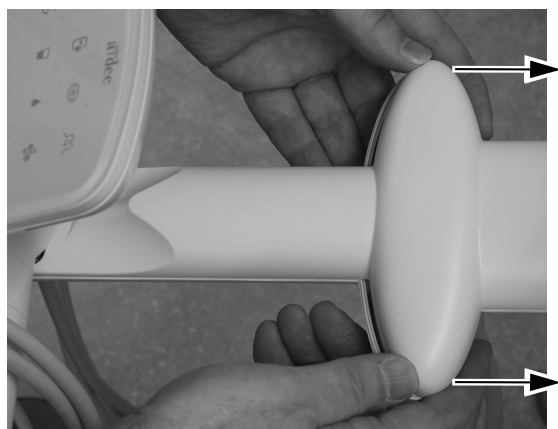

- 4** Pull the ultrasonic handpiece tubing up through the instrumentation arm so that it matches the drape of other handpieces. Secure the tubing to the instrumentation arm by passing a cable tie through the cable tie hold down and wrapping it around the tubing.

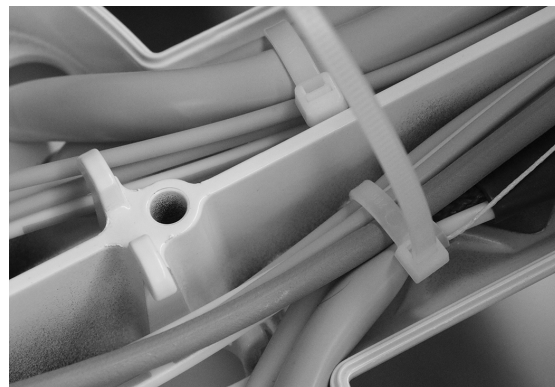
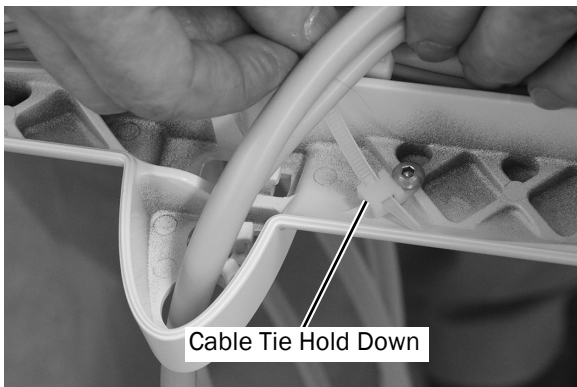

- 5** Tighten the cable tie so it is snug. Use diagonal cutters to trim the excess cable tie.

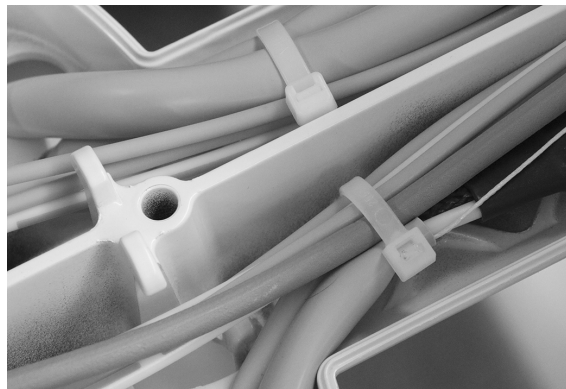

- 6** Route the ultrasonic handpiece tubing down through the vertical post of the instrumentation arm.

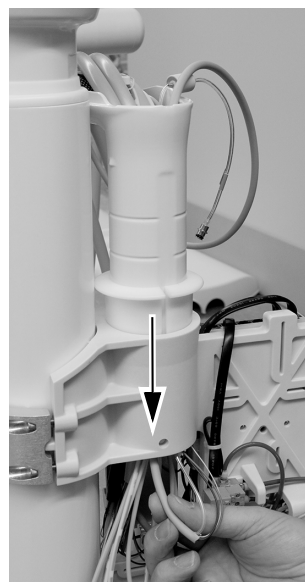

Mount the Control Module on the 12 O'Clock Frame Unit

- 1 To ensure maximum flexibility for future installations, note the recommended placement of the ultrasonic handpiece control module as shown below.

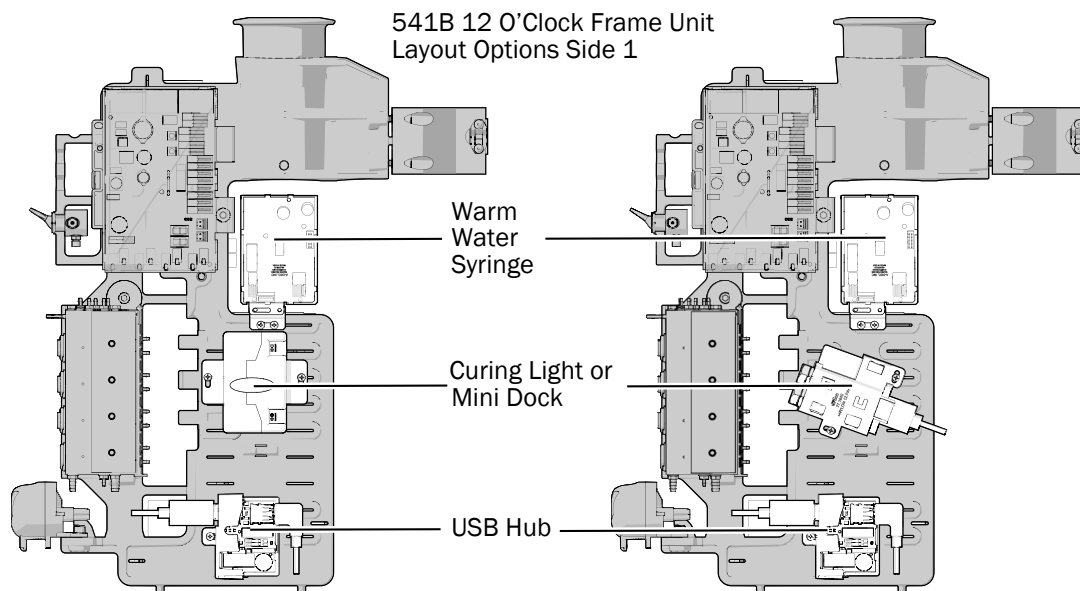
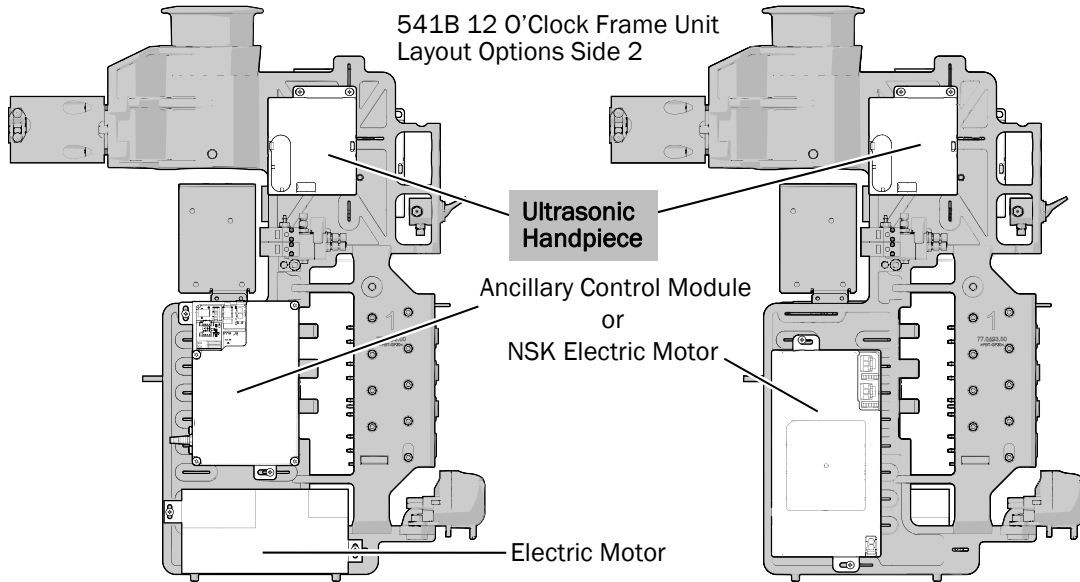



ATTENTION Circuit boards are sensitive to static electricity. Electrostatic Discharge (ESD) precautions are required when touching a circuit board or making connections to or from the circuit board. Circuit boards should be installed only by an electrician or qualified service person.

- 2 Place an anti-static wrist strap snugly on one wrist and connect the other end of the strap to the grounding lug located near the edge of the control head circuit board.

Grounding Lug

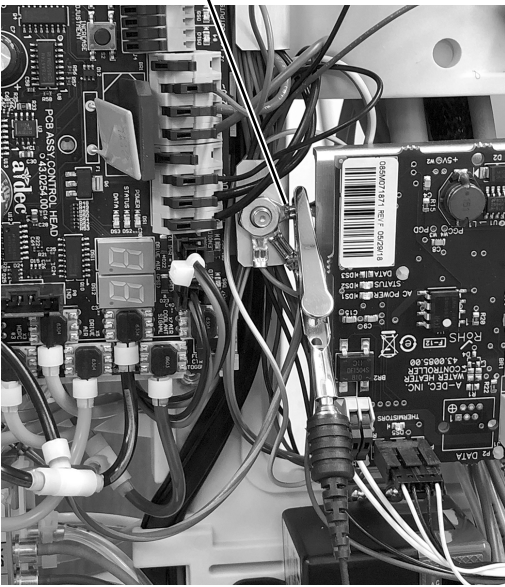

- 3 Place the control module on the 12 o'clock frame unit. Orient the control module as shown below. Secure the module using one screw.



Connect the Control Module Electrical Wires

- 1 Connect the adaptor harness to the ultrasonic handpiece control module.

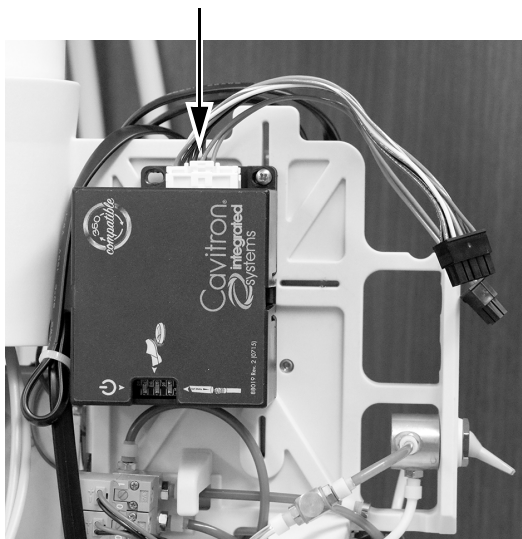

- 2 Connect the 4-pin socket from the handpiece tubing to the 4-pin plug from the adaptor harness.

- 3 Connect the 10-pin socket from the control harness to the 10-pin plug from the adaptor harness.

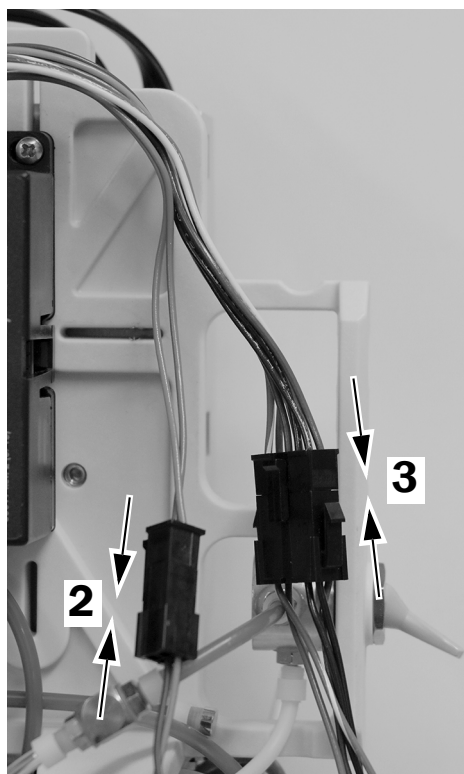

- 4** Route the wiring from the 10-pin connector through the frame unit to the side where the delivery system circuit board is located.

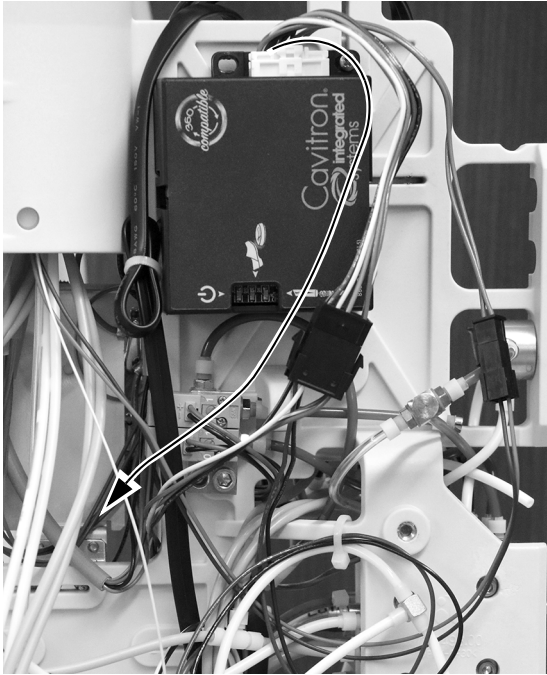

CAUTION Do not connect the black and yellow wires to the 0 VAC or 24 VAC SCALER terminals.

- 5** Connect the blue, blue with white stripe wires to the WAGO® connectors. Connect the black and yellow wires to the delivery system circuit board.

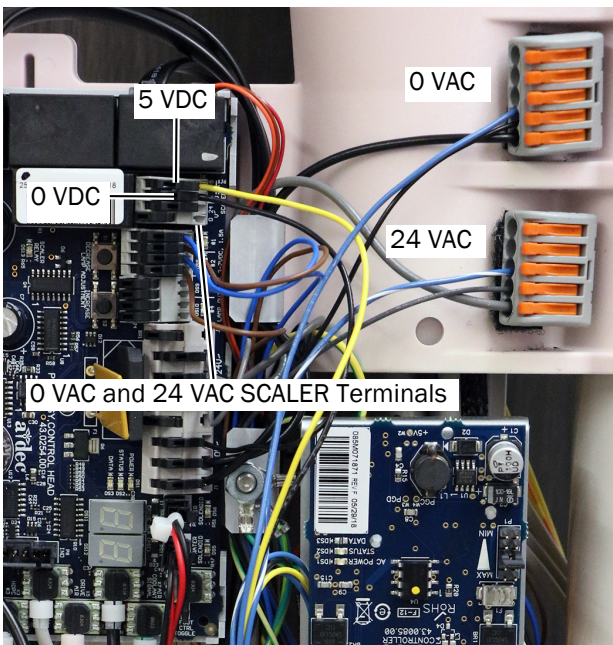

Connect the wires as follows:

- Blue to 0 VAC
- Blue with White Stripe to 24 VAC
- Black to 0 VDC
- Yellow to 5 VDC



NOTE Ensure that the circuit board contacts do not close on the insulation of the wire.

Connect the Handpiece Tubing to the Control Block

- 1 Connect the clear tubing from the handpiece tubing to the OUT barb on the water regulator.

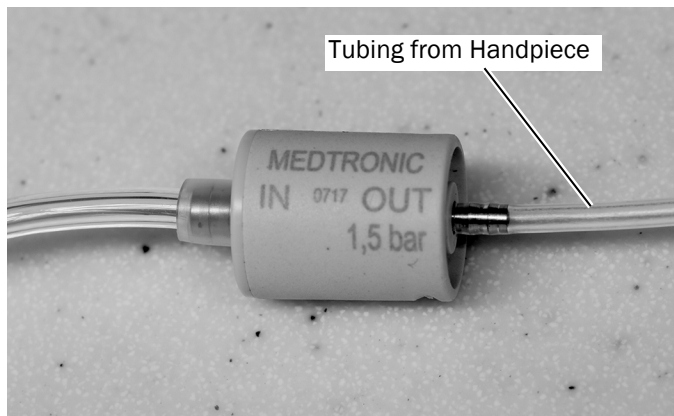

- 2 Loop the black and brown wiring and yellow tubing from the air-electric switch together and use a cable tie to secure the air-electric switch tubing and wiring to the 12 o'clock frame unit.

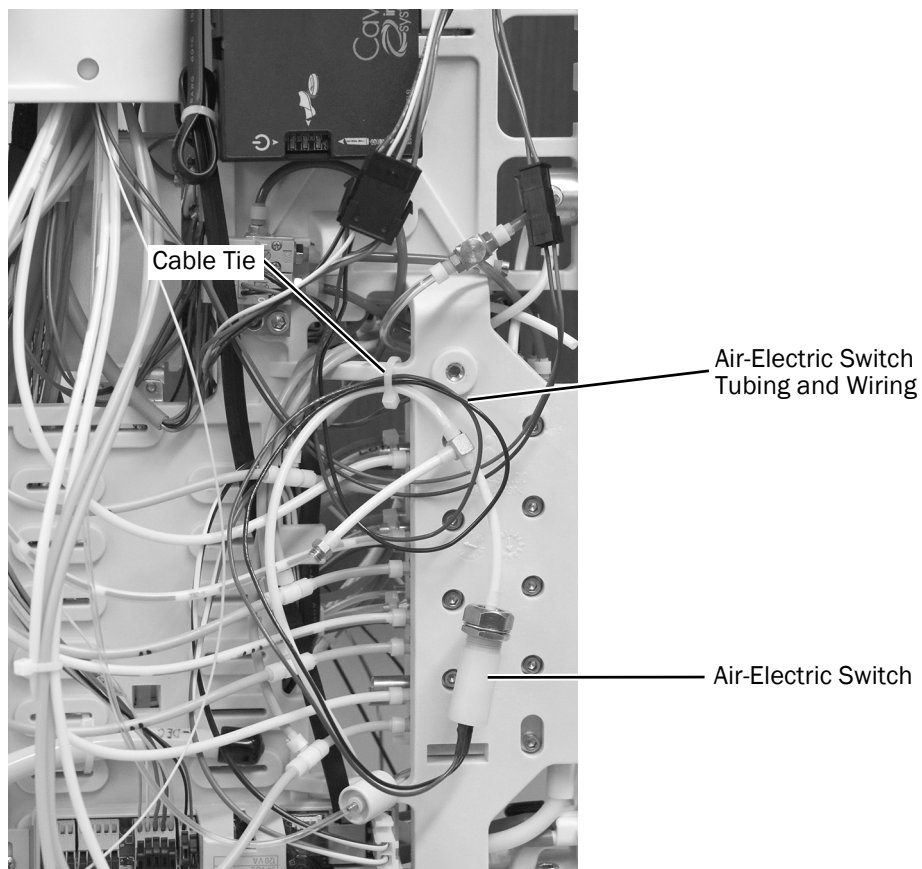

- 3 Route the clear tubing from the IN barb on the water regulator through the 12 o'clock frame unit to the control block side.
- 4 Route the yellow drive air tubing from the air-electric switch through the 12 o'clock frame unit to the control block side.

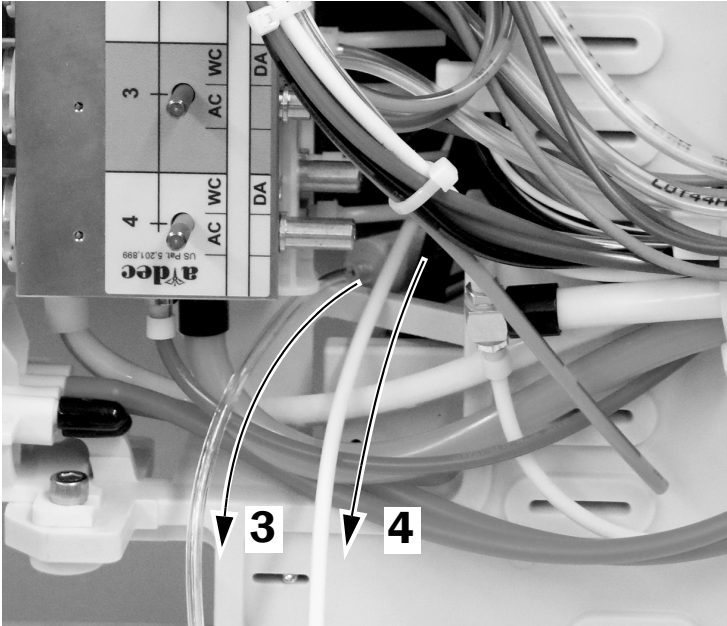



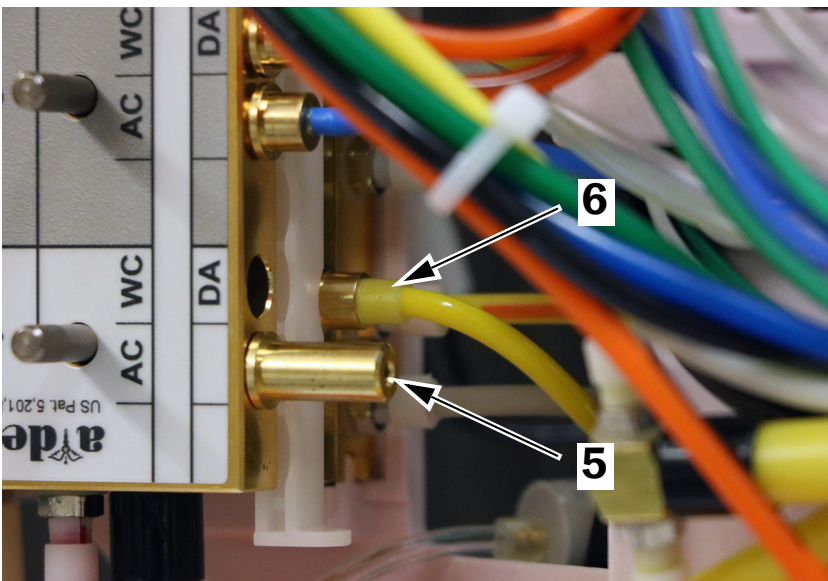



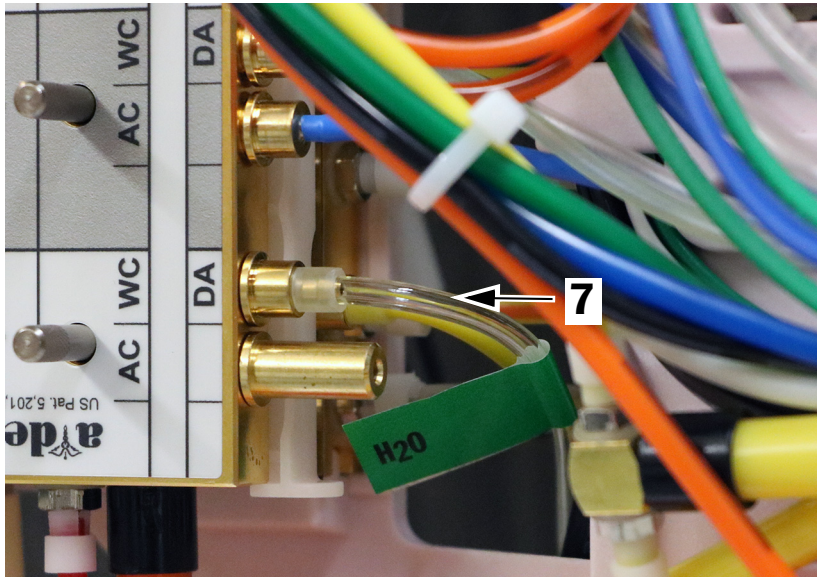









- 5 Insert a quick-disconnect plug into the AC air coolant port on the control block for the desired handpiece position on the control block.
- 6 Connect the air-electric switch yellow tubing quick-disconnect adaptor to the DA drive air port for the desired handpiece position on the control block.



- 7 Attach the clear water line tubing from the IN barb on the water regulator to the appropriate WC water coolant port on the control block.



Configure the Handpiece Settings

- 1** Turn on the power to the system.
- 2** Press and hold  and  at the same time until a **System Setup** screen appears.
- 3** Press .
- 4** Press  again to select **Handpieces**.
- 5** Press  on the **Handpiece Setup** screen to select **Holder Setup**.
- 6** Lift the handpiece from the holder.
- 7** Press  or  to change the highlighted choice to **Ultrasonic** and press  to select it.
- 8** Return the handpiece to the holder.
- 9** Press  to return to the previous screen.
- 10** Press  or  to change the highlighted choice to **Ultrasonic Setup** and press  to select it.
- 11** Check that **Acteon® colors** is set to **OFF**. If needed, touch  or  to turn off **Acteon colors**.
Touch  to save your setting.
- 12** Press  until you see the A-dec logo.

Test the Installation

- 1** Verify that the power to the system is on. Verify that the air supply is turned on.
- 2** Fill the self-contained water bottle with water.
- 3** Lift the handpiece tubing from the handpiece holder or pull the whip forward.
- 4** Align the Steri-Mate handpiece and the handpiece tubing and plug the handpiece into the tubing.
- 5** Turn the water flow control knob for the handpiece position clockwise until it stops. Turn the water flow control knob counter-clockwise six full turns to set the water flow control to maximum. If you are using a disc foot control, flip the foot control water toggle switch to on.
- 6** Turn the Steri-Mate handpiece water flow control to maximum.
- 7** Press on the disc foot control or move the level foot control all the way to the left for two minutes to flush out the water system. Hold the handpiece vertically to fill the handpiece with water. Release the foot control.
- 8** Place a Cavitron insert into the Steri-Mate handpiece.
- 9** Activate the foot control disc or lever and verify the insert oscillates.
- 10** Adjust the ultrasonic handpiece power using the touchpad. Verify the ultrasonic handpiece power changes with the touchpad settings.
- 11** Verify the water flow is adjustable from zero to maximum flow using the flow control at the rear of the handpiece.
- 12** Release the foot control and verify there are no water leaks.
- 13** Verify the wires and tubing are not trapped or kinked.

Adjust the Handpiece Drive Air Pressure

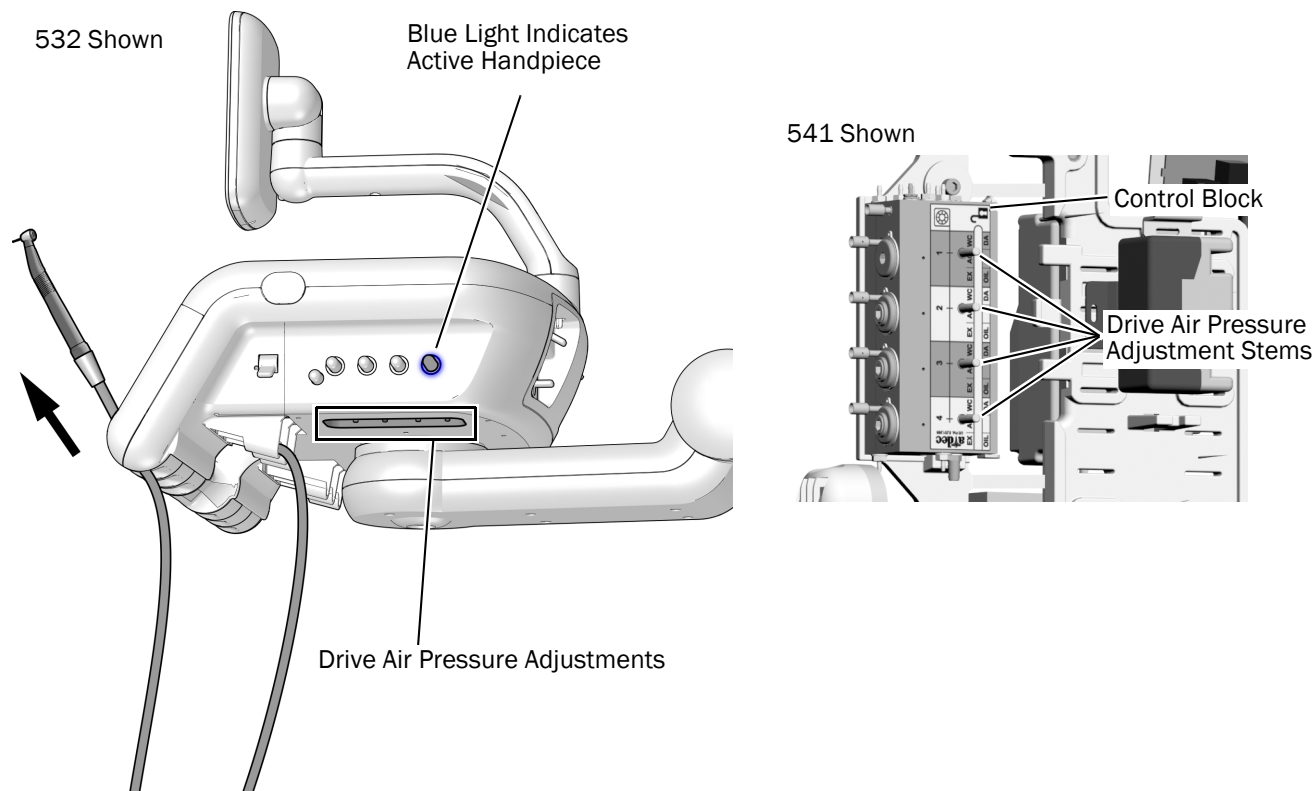

- 1** Make sure the water coolant is turned off at the foot control.
- 2** To show the drive air pressure on the deluxe plus touchpad, touch **—** and **+** at the same time. A handpiece must be attached to the tubing to read the pressure.
- 3** Lift the handpiece from the holder or pull the whip forward.
- 4** A blue light around the water coolant adjustment knob indicates which handpiece is active. Locate the corresponding drive air pressure adjustment stem.
- 5** Fully press the foot control to run the handpiece and adjust the drive air pressure. Adjust the pressure until it reads between 60 and 65 psi (414 to 448 kPa).



NOTE Pressure can also be measured with a handpiece pressure gauge. When adjusting the drive air pressure, take into account where it is measured. Pressure is greater at the control head, as read through the deluxe plus touchpad, than at the handpiece.

Reinstall the Covers



CAUTION When removing or replacing covers, take care not to damage any wiring or tubing. Verify that the covers are secure after replacing them.

532B: Reinstall the Front and Top Covers	31
533B: Reinstall the Instrument Pad	32
541B: Reinstall the Delivery System Covers	33

532B: Reinstall the Front and Top Covers

- 1** Replace the front cover on the control head.

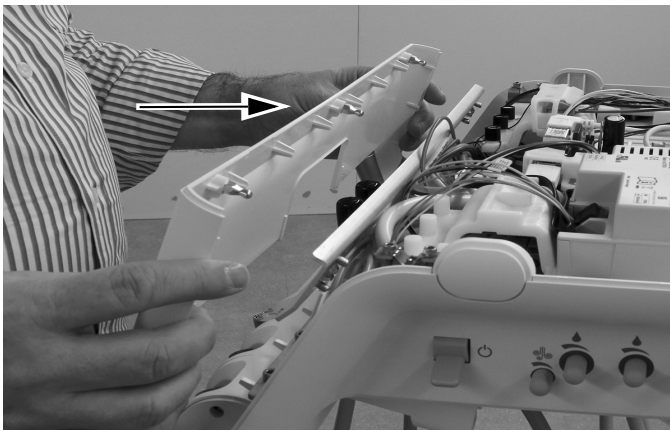

- 2** Reinstall the top cover.



533B: Reinstall the Instrument Pad

- 1 Pull each of the whips behind the removed instrument pad out of the control head.

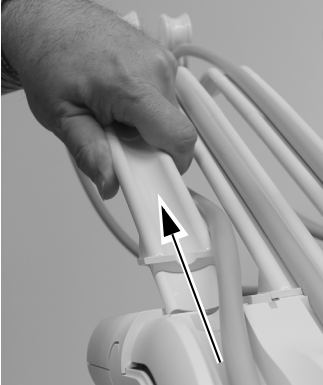

- 2 Reinstall the instrument pad on the control head and press it into place. Press all around the edges of the instrument pad to ensure that it is fully seated on the control head.



- 3 Insert the whips into the control head. Ensure the top edge of the instrument pad is fully seated before you insert the whips.

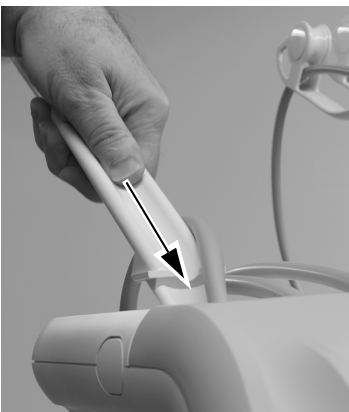

- 4 Reinstall the handpiece tubing into the whips.

541B: Reinstall the Delivery System Covers

- 1 Place the top cover on the instrumentation arm and slide the top cover toward the touchpad.

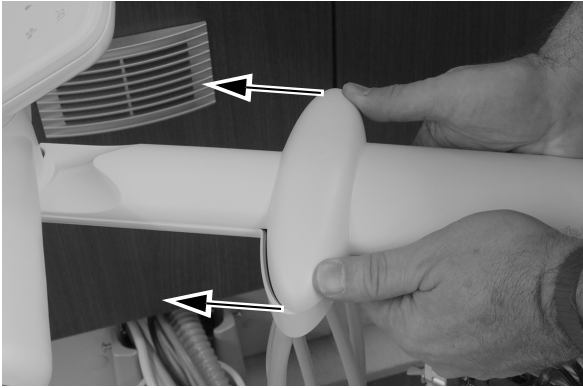

- 2 Use a 5/32" hex key to reinstall the screw that secures the top cover on the instrumentation arm.

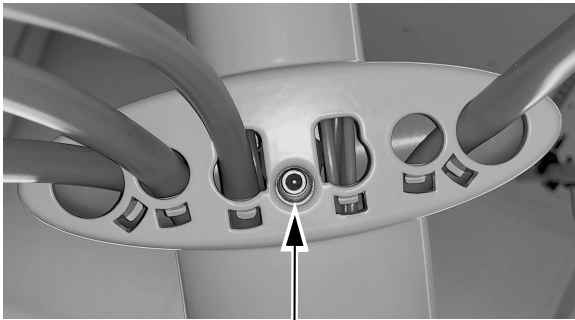

- 3 Reinstall the side covers.



Regulatory Information and Warranty

For required regulatory information and the A-dec warranty, see the *Regulatory Information, Specifications, and Warranty* document (p/n 86.0221.00) available in the Resource Center at www.a-dec.com.

Dentsply, Cavitron, and Steri-Mate are registered trademarks of Dentsply Sirona Inc.
Acteon is a registered trademark of Financiere Acteon SAS.
All other trademarks cited herein are the property of their respective owners.



A-dec Headquarters

2601 Crestview Drive
Newberg, OR 97132 USA
Tel: 1.800.547.1883 Within USA/CAN
Tel: +1.503.538.7478 Outside USA/CAN
Fax: 1.503.538.0276
www.a-dec.com

A-dec Inc. makes no warranty of any kind with regard to the content in this document including, but not limited to, the implied warranties of merchantability and fitness for a particular purpose.



86.0769.00 Rev B
Date of Issue 2021-05-07
Copyright 2021 A-dec, Inc.
All rights reserved.
IGrphpor18